

# ***ATC41-ISO20***

# ***INSTRUCTION***

# ***MANUAL***

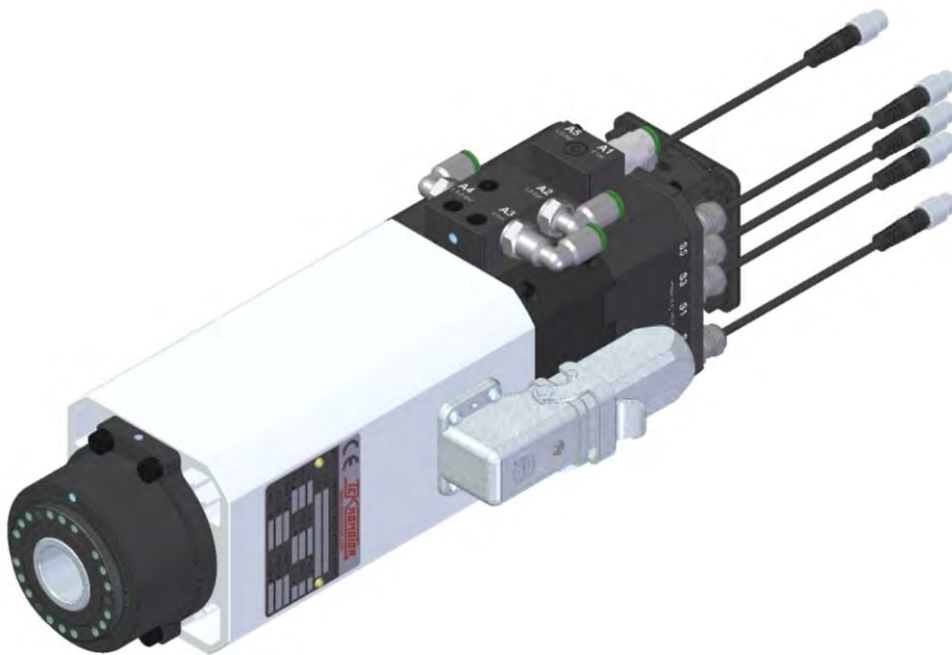

***Practical guide to the correct use of  
Automatic Tool Changer ISO20***



**This manual contains information protected by copyright. It and its attachments shall not be photocopied or reproduced in any form, either fully or in part, without the prior written consent of TEKNOMOTOR S.R.L.**



## USER MANUAL REVISION TABLE:

Revision no.	Revision date	Revision description	Author
02	11/11/2019	Aggiunto render al § 8.3.1	D. Bottarel
01	21/06/2019	Aggiunto tavole	D. Bottarel
00	13/12/2018	Emissione	D. Bottarel

Technical Department of TEKNOMOTOR S.R.L. has written this user manual.

The manual addresses to installers, operators and service technicians working with TEKNOMOTOR S.R.L. electrospindles.

TEKNOMOTOR S.R.L. supplies the manual together with its electrospindles at the last revision available.

## ATTACHMENTS:

Attachments listed below are integral part of the user manual and shall be read and understood in conjunction with to avoid missing important information:



- GENERAL VIEW DRAWINGS WITH OVERALL DIMENSIONS, PERFORMANCE DATA AND ELECTRICAL SPECIFICATIONS
- MANUFACTURER DECLARATION OF CONFORMITY (EU)
- POWER-TORQUE SPEED DIAGRAM (IF REQUESTED BY CUSTOMER)

Listed attachments can be embedded in this user manual or constitute a separate document or data sheet. Check that all above documents are disposable before installing, operating or maintaining TEKNOMOTOR S.R.L. electrospindles covered by this user manual.

Ask Technical Department of TEKNOMOTOR S.R.L. [tecnico@teknomotor.com](mailto:tecnico@teknomotor.com) for missing information or documentation.



# DISCLAIMER:

	<p><b>USE THE ELECTROSPINDLE ONLY FOR THE PURPOSE FOR WHICH TEKNOMOTOR S.R.L. DESIGNED IT.</b></p> <p><b>SAFE OPERATION DEPENDS ON THIS.</b></p> <p><b>WARRANTY AND LIABILITY UNDER GENERAL SALES CONDITIONS OF TEKNOMOTOR DEPEND ON THIS AND THEY WILL LAPSE IF THE INSTRUCTIONS PROVIDED IN THIS USER MANUAL WILL NOT STRICTLY APPLIED.</b></p>
	<p><b>INSTALL THE ELECTROSPINDLES AS DESCRIBED IN THE FOLLOWING SECTIONS OF THIS MANUAL AND ATTACHED TECHNICAL DOCUMENTATION.</b></p> <p><b>SAFE OPERATION DEPENDS ON THIS.</b></p> <p><b>WARRANTY AND LIABILITY UNDER GENERAL SALES CONDITIONS OF TEKNOMOTOR DEPEND ON THIS AND THEY WILL LAPSE IF THE INSTRUCTIONS PROVIDED IN THIS USER MANUAL WILL NOT STRICTLY APPLIED.</b></p>





# INDEX

USER MANUAL REVISION TABLE: .....	6
ATTACHMENTS: .....	6
DISCLAIMER: .....	8
INDEX .....	10
1. INTRODUCTION .....	14
1.1. SYMBOLS AND SAFETY SIGNS USED IN THE MANUAL .....	14
1.2. PURPOSE .....	15
2. WARNING AND SAEFTY PRECAUTIONS .....	16
2.1. RISKS ASSOCIATED WITH IMPROPER USE AND HANDLING .....	16
2.2. RISKS SPECIFIC TO ELECTROSPINDLE MAINTENANCE .....	17
3. GENERAL INFORMATION .....	17
3.1. PROPER USE OF ELECTROSPINDLE .....	17
3.2. RANGE OF APPLICATION .....	18
4. TECHNICAL SPECIFICATIONS .....	19
4.1. THE MAIN PARTS OF THE ELECTROSPINDLE .....	19
4.2. IDENTIFYNG THE MOTOR DATA FROM THE NAME PLATE .....	20
4.3. GENERAL VIEWS, OVERALL DIMENSIONS AND PERFORMANCE .....	20
5. TRASPORT, PACKAGING, UNPACKAGING AND STORAGE .....	21
5.1. PACKAGING AND LIFTING .....	21
5.2. STORAGE .....	21
6. INSTALLATION .....	22
6.1. CHECKING FOR DAMAGE .....	22
6.2. PROVISION OF ON SITE INSTALLATION EQUIPMENT .....	22
6.3. MECHANICAL CONNECTIONS .....	22
6.3.1. POSITIONING OF ELECTROSPINDLE .....	22
6.3.2. ELECTROSPINDLE RESTING SURFACE .....	22
6.3.3. TOOL CHANGE SYSTEM .....	23
6.3.4. FIXING ELECTROSPINDLE .....	23
6.4. PNEUMATIC CONNECTION .....	23
6.4.1. AIR PURITY .....	23
6.4.2. PNEUMATIC CONNECTION DIAGRAM .....	24
6.5. PNEUMATIC SPINDLE NOSE CLEANING .....	26
6.6. NOSE PRESSURISATION .....	26
6.7. ELECTRICAL CONNECTIONS .....	26
6.7.1. STANDARD LAYOUT OF POWER CONNECTOR .....	26

6.7.2.	LAYOUT OF SIGNAL CONNECTOR .....	27
6.8.	ELECTRIC FAN .....	27
7.	GENERAL CHECKS AFTER INSTALLATION IN THE MACHINE AND PRIOR START-UP .....	28
7.1.	CHECKING ON THE ELECTROSPINDLE PRIOR TO START-UP .....	28
7.2.	CHECKING ON THE ELECTROSPINDLE AT THE TIME OF FIRST START-UP.....	29
7.3.	CHECKING ON THE ELECTROSPINDLE BEFORE RUNNING IT.....	29
8.	OPERATION OF THE ELECTROSPINDLE .....	30
8.1.	CLIMATIC LIMITATIONS .....	30
8.2.	FORECAST AND NON FORECAST USE .....	30
8.3.	RUNNING IN.....	30
8.4.	WARMING UP .....	31
8.5.	TOOL-HOLDER LOCKING AND EXPULSION DEVICE.....	31
8.6.	TOOL-HOLDER CONE .....	31
8.7.	INSTALLATION OF THE PULL STUD ON THE ISO20 CONE.....	31
8.8.	GENERAL RACCOMANDATION FOR THE TOOL HOLDER CONES .....	32
8.9.	TOOL MOUNTING – TOOLHOLDER .....	32
8.10.	TOOL MOUNTING – TOOLHOLDER WITH CONICAL SEAT FOR ER DIN 6499.....	34
	Excessive tool run-out causes premature wear of bearings. ....	34
8.11.	MAXIMUM RUN-OUT AND VIBRATION VALUES .....	35
8.12.	SPEED LIMITS .....	35
8.13.	WHAT TO DO IF THE TOOL IS BLOKED ON THE PIECE BEING WORKED .....	36
8.14.	SENSORS .....	36
8.14.1.	TECHNICAL CHARACTERISTICS OF THE INDUCTIVE SENSORS.....	36
8.14.2.	STATUS MODES OF THE ELECTROSPINDLE AND CORRESPONDING OUTPUTS .....	37
8.14.3.	TRIMMING SENSORS .....	38
8.14.4.	SENSOR S3 OUTPUT (option).....	39
8.14.5.	THERMAL ALARM .....	39
9	MAINTENANCE .....	40
9.1.	SCHEDULED MAINTENANCE AND CLEANING THE SPINDLE SHAFT TOOL HOUSING.....	41
9.1.1.	CHECK THE GRIPPER TIGHTENING .....	41
9.1.2.	CHECK THE CLEANING OF TOOL-HOLDER CONE AND CONICAL HOUSING OF THE ELECTROSPINDLE SHAFT .....	41
9.1.3.	PROTECTING THE CONICAL SEAT IN THE SPINDLE SHAFT .....	42
9.1.4.	CLEANING THE TOOL-HOLDER CONE.....	42
9.1.5.	CHECK THE CONNECTIONS .....	42
9.2.	OCCASIONAL MAINTENANCE .....	42
10.	TROUBLESHOOTING .....	43
11.	DISPOSING OF THE ELECTROSPINDLE.....	43
12.	USEFULL ADRESSES.....	44

APPENDIX: ATC41 DRAWINGS AND POWER-TORQUE CURVES..... 46

Figure 1 Main part of the electrospindle ..... 19

Figure 2 Typical Teknomotor electrospindle nameplate..... 20

Figure 3 Air connections ..... 25

Figure 4 Power supply connector ..... 26

Figure 5 Electrical sensor connection..... 27

Figure 6 Pin number ..... 27

Figure 7 Sensor plug ..... 27

Figure 8 V-f pattern..... 28

Figure 9 Sensors cover dismounting      Figure 10 Trimming sensor system ..... 38

***This manual contains information protected by copyright. It and its attachments shall not be photocopied or reproduced in any form, either fully or in part, without the prior written consent of TEKNOMOTOR S.R.L.***









# 1.INTRODUCTION

## 1.1. SYMBOLS AND SAFETY SIGNS USED IN THE MANUAL

This manual highlights important instructions or precautions with the following symbols and safety signs (ref. ISO 7010):

*NOTE: information highlighted by symbols and safety signs is not exhaustive and the whole manual shall be read and applied*

	<p><b>IMPORTANT INFORMATION</b></p>
	<p><b>GENERAL WARNING IDENTIFIED BY SUPPLEMENTARY SAFETY INFORMATION</b></p>
	<p><b>WARNING: SHARP ELEMENT</b></p>
	<p><b>WARNING: FLAMMABLE MATERIAL</b></p>
	<p><b>WARNING: ELECTRICITY</b></p>
	<p><b>GENERAL MANDATORY ACTION IDENTIFIED BY SUPPLEMENTARY SAFETY INFORMATION</b></p>
	<p><b>REFER TO INSTRUCTION MANUAL BOOKLET</b></p>

	<p><b>DISCONNECT BEFORE CARRYING MAINTENANCE OR REPAIR</b></p>
---	--

## 1.2. PURPOSE

This user manual contains important instructions and precautions and shall accompany the electrospindle at all times since it is essential for the safe operation of the electrospindle and operators.



Safety precautions contained herein provide information necessary to ensure the safety of all persons exposed to the residual risks associated with the electrospindle.

Instructions contained herein provide information necessary for the correct operation of the electrospindle.

Make sure that you read and fully understand all the documentation supplied with the electrospindle to avoid incorrect operation of the unit and unnecessary risks of personal injury.

Keep this manual easily available in a suitable place near the machine-

Keep this manual safe, and ensure that all persons involved with the electrospindle know of it, fully understand its contents and have access to it.

	<p><b>IMPORTERS AND DISTRIBUTORS SHALL ENSURE THAT USER MANUAL ALWAYS ACCOMPANIES THE ELECTROSPINDLE AND THAT CONSUMER, MACHINE MANUFACTURER AND OTHER END-USERS CAN EASILY FULLY UNDERSTOOD IT.</b></p>
	<p><b>USE THE ELECTROSPINDLE ONLY FOR THE PURPOSE FOR WHICH TEKNOMOTOR S.R.L. DESIGNED IT.</b></p> <p><b>SAFE OPERATION DEPENDS ON THIS.</b></p> <p><b>WARRANTY AND LIABILITY UNDER GENERAL SALE CONDITIONS OF TEKNOMOTOR DEPEND ON THIS AND THEY WILL LAPSE IF THE INSTRUCTIONS PROVIDED IN THIS USER MANUAL WILL NOT STRICTLY APPLIED.</b></p>
	<p><b>INSTALL THE ELECTROSPINDLES AS DESCRIBED IN THE FOLLOWING SECTIONS OF THIS MANUAL AND ATTACHED TECHNICAL DOCUMENTATION.</b></p> <p><b>SAFE OPERATION DEPENDS ON THIS.</b></p> <p><b>WARRANTY AND LIABILITY UNDER GENERAL SALE CONDITIONS OF TEKNOMOTOR DEPEND ON THIS AND THEY WILL LAPSE IF THE INSTRUCTIONS PROVIDED IN THIS USER MANUAL WILL NOT STRICTLY APPLIED.</b></p>

## 2. WARNING AND SAFE TY PRECAUTIONS



***Teknomotor S.r.l. does not and cannot know how end users will install their electrospindles. The installer or customer must therefore perform risk assessment specific to each installation and application.***

It is also the responsibility of the installer to ensure that adequate guards are provided to prevent accidental contact with moving parts.

The installer and the operator must also bear in mind other types of risk, particularly those associated with foreign bodies, explosive, inflammable, toxic or high temperature gasses.

Risks associated with maintenance operations must also be guarded against. Maintenance must be performed in conditions of maximum safety, and only with the electrospindle fully stationary and switched off.

Once the electrospindle has been installed in the way decided upon by the installer and/or customer, the machine becomes a “finished machine” as defined for the purposes of the Machinery Directive. Overall risk assessment must therefore be performed on the finished machine and a declaration of conformity produced in compliance with Appendix IIA of the 98/37/CE Machinery Directive.

### 2.1. RISKS ASSOCIATED WITH IMPROPER USE AND HANDLING

- Never impede the functioning of, remove, modify or in any way interfere with any safety device, guard, or control of individual parts or of the electrospindle as a whole.
- Never place your hands, arms, or any other part of your body near moving machinery.
- Never push objects through the cover grill or into the electrospindle either when it is stationary or when it is operating.
- Do not use the electrospindle in atmospheres or environments where there is a risk of explosion.
- Unless you are duly authorized, never attempt to repair faults or electrospindle malfunctions and never interfere in any way with the electrospindle operation or installation.
- On completion of servicing work for which guards, covers, or any other protections have been removed, always make sure that they have been correctly and securely replaced and are fully functional before re-starting the electro spindle.
- Keep all protection and safety devices in perfect working order. Also make sure that all warning and informative plates, labels and symbols are correctly positioned and perfectly legible.
- When troubleshooting the electrospindle always adopt all the safety precautions listed in this manual for the purpose of preventing injury or damage to persons and things.
- After adjusting any mechanical part, make sure that you fully tighten all screws, bolts or ring nuts you may have slackened or removed.
- Before you start the electrospindle, make sure that all the safety devices are installed and perfectly functional. Do not start the electrospindle if this is not the case, but immediately inform the person responsible for machine safety or your direct superior.
- Make sure that you have and use all the personal protective equipment (PPE) required by law. Do not wear loose or hanging clothing (ties, wide sleeves, etc.).
- Never use types of tool holder that do not correspond to the models those are specify in this manual; this cause the risk of breakage or imperfect hook-up of the tool holder cone.

## 2.2. RISKS SPECIFIC TO ELECTROSPINDLE MAINTENANCE



- During all maintenance and cleaning operations, take great care if a tool is fitted. It is advisable to remove any tool before starting cleaning or maintenance.
- Disconnect the electrospindle from the main supply before carrying out any maintenance operations.
- The electrospindle can still turn under the effect of inertia even after it has been switched off. Make absolutely sure that the electrospindle is not still spinning before starting any maintenance on it.
- Perform scheduled maintenance as specified in this manual to avoid the risk of mechanical failures from advanced wear.

	<p><b><i>NEVER Start any maintenance before making absolutely sure the electrospindle is stopped spinning.</i></b></p> <p><b><i>NEVER Start any maintenance on the electrospindle without first disconnecting it from the electrical power supply.</i></b></p> <p><b><i>NEVER Attempt to clean the electrospindle while it is rotating.</i></b></p>
---	---

# 3. GENERAL INFORMATION

## 3.1. PROPER USE OF ELECTROSPINDLE

Electrospindles designed by TEKNOMOTOR S.R.L. shall operate as part of a machine.

  	<p><b><i>MACHINE DESIGN SHALL CONSIDER THAT FRAME OF THE MACHINE SHALL WITHSTAND THE WEIGHT OF ELECTROSPINDLE FITTED IN AND THE STRESSES CAUSED BY TYPE OF MACHINING TO CARRY OUT.</i></b></p>
	<p><b><i>TEKNOMOTOR S.R.L. DESIGNED ELECTROSPINDLE FOR LOW-MEDIUM POWER MILLING AND DRILLING OF WOOD, FIBERBOARD, PLASTICS AND ALUMINUM (SEE TO TECHNICAL DATA OF THE SPECIFIC ELECTROSPINDLE MODEL).</i></b></p>
	<p><b><i>USE THE ELECTROSPINDLE ONLY FOR THE PURPOSE FOR WHICH TEKNOMOTOR S.R.L. DESIGNED IT.</i></b></p> <p><b><i>SAFE OPERATION DEPENDS ON THIS.</i></b></p>
	<p><b><i>ELECTROSPINDLES OPERATE AT S1 DUTY CYCLE UNLESS OTHERWISE IN TECHNICAL DOCUMENTATION OF THE SPECIFIC MODEL.</i></b></p> <p><b><i>CUSTOMER SHALL CARRY OPERATION OF THE ELECTROSPINDLE ACCORDING TO SERVICE TYPE INDICATED IN TECHNICAL DOCUMENTATION.</i></b></p>





**SERVICE TYPE S1 (standard IEC 60034-1) MEANS OPERATION AT CONSTANT LOAD WITH A DURATION SUFFICIENT TO ENSURE THAT THE MOTOR REACHES THERMAL EQUILIBRIUM.**

### **3.2. RANGE OF APPLICATION**

The product has been designed to carry out milling and boring operations in the field of wood and its derivatives, plastic, composite material, aluminum and light machining operations on other metals.

The quick replacement of the shaft unit complete with bearings is possible on every models, using the shaft kit. For further information contact the Teknomotor Technical Office.

All the electrospindles have a mechanical reaction system that almost completely cancels the axial force of the pistons on the bearing during the tool changing phase. It guarantees the long life of the front precision bearings.

# 4. TECHNICAL SPECIFICATIONS

## 4.1. THE MAIN PARTS OF THE ELECTROSPINDLE

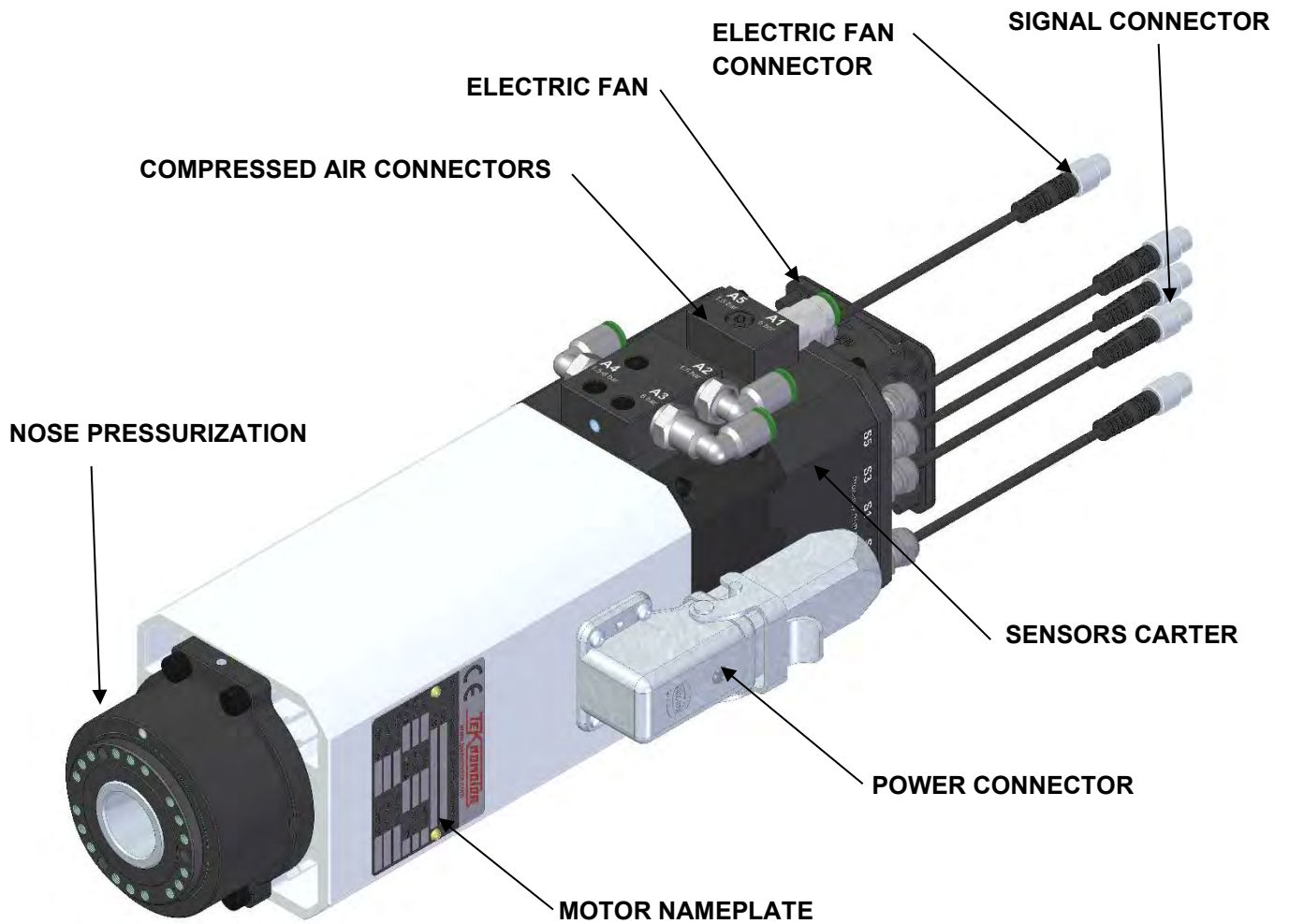

Figure 1 Main part of the electrospindle

### 4.2. IDENTIFYING THE MOTOR DATA FROM THE NAME PLATE

The part number (P.N. or TYPE) and the serial number (S.N.) are printed on the name plate and they are only way to identify the electrospindle recognized by the manufacturer. For this reason they must be kept legible throughout the unit's working life. The place of the name plate and the disposition of data in the name plate could be different model by model.

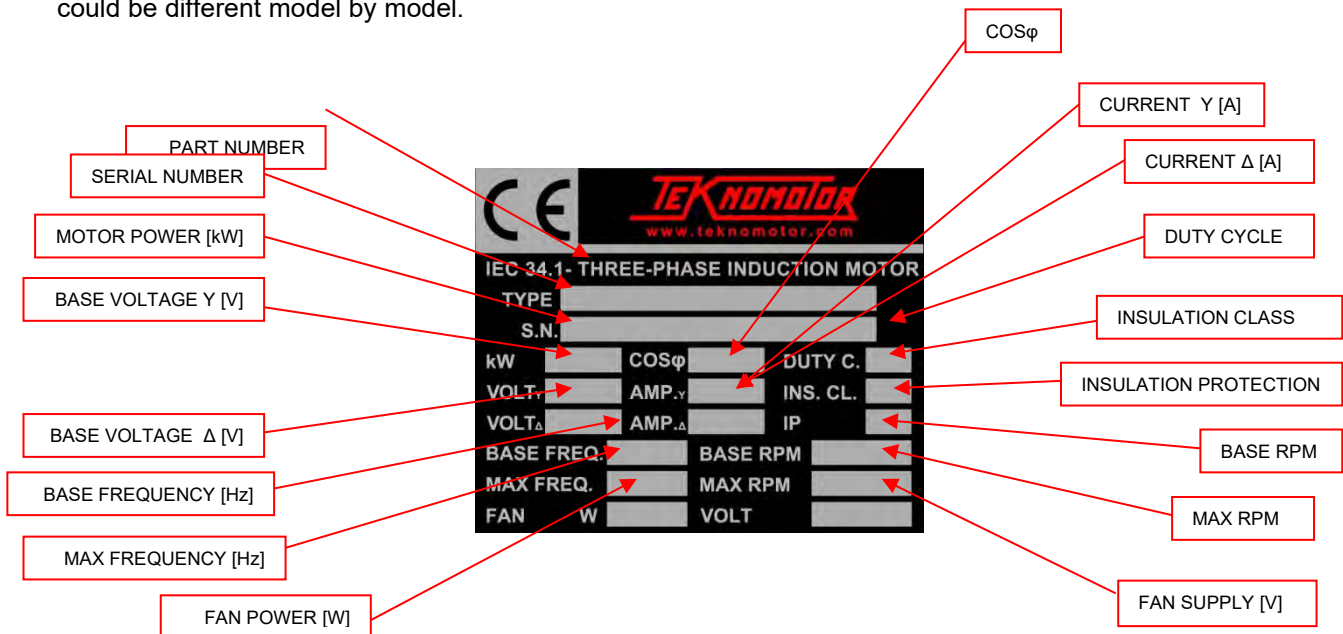

Figure 2 Typical Teknomotor electrospindle nameplate

### 4.3. GENERAL VIEWS, OVERALL DIMENSIONS AND PERFORMANCE

See attached documents. If the document is not available please contact Teknomotor technical office.

## 5. TRASPORT, PACKAGING, UNPACKAGING AND STORAGE

### 5.1. PACKAGING AND LIFTING

- Lifting and moving the electrospindle can create situations of risk to persons nearby. Always follow the instructions provided by this manual, follow all possible safety instruction for the handling of heavy loads. Always use suitable lifting equipment. The responsibility for the safety of the people involved in handling, moving and lifting operation is of the customer.
- Installation and assembly work must be performed only by specialist technicians.
- Always use great care in lifting and moving electrospindles and their components. Avoid impacts which can damage the body or the shaft or the bearings of the electrospindle.



***It is the responsibility of the customer to ensure that the lifting equipment used is suitable for the purpose in terms of functioning and load capacity.***

***Never lift the electrospindle by its fan cover. This can break, damaging the electrospindle and possibly causing personal injury.***

***Never drill parts of electrospindle to attach elements useful to move electrospindle.***

#### Load characteristics

The load is to be considered too heavy for a single person when:

- It weights for more than 30 kg for men
- It weights for more than 20 kg for women

Do not drill the electrospindle to fit any hoisting tool.

### 5.2. STORAGE

If the electrospindle is to be stored for any length of time, make sure that it is protected against the elements and in particular against damp, dust, and other forms of damage by the atmosphere or storage environment.

**STORAGE TEMPERATURE: from -5°C to +55°C**  
**NON-CONDENSING RELATIVE HUMIDITY: from 5% to 15%**



***The storage time of Teknomotor electrospindle is 12 months. After this time-limit the product must be inspected by an authorized Teknomotor service. If you need more information please contact Teknomotor S.r.l..***

## 6. INSTALLATION

### 6.1. CHECKING FOR DAMAGE

Before starting installation, check:

- That no part of electrospindle has been damaged during transport and/or handling,
- That there is no sign of damp or water inside the connection terminal board,
- That the terminal board and its cover are not damaged in any way.

	<p><b><i>IF THE ELECTROSPINDLE IS DAMAGED INFORM IMMEDIATELY THE TRANSPORTER AND TEKNOMOTOR S.R.L.</i></b></p>
---	--

### 6.2. PROVISION OF ON SITE INSTALLATION EQUIPMENT

All work in preparation for installation of the electrospindle is the responsibility of the customer (e.g. preparation of electrical power supplies, compressed air pipe etc.).

Make sure that the electrical power line to the electrospindle is of adequate section and power. Connection of the unit to the power supply must only be done by qualified electricians. The customer is responsible for all parts of the electrical power supply to the electrospindle.

	<p><b><i>ATTENTION: the customer is expressly reminded that the electrospindle must be correctly connected to earth. Furthermore, the earth connection must comply with applicable regulations in the country in which the unit is installed and must be duly checked and tested by a qualified electrician.</i></b></p>
---	--

### 6.3. MECHANICAL CONNECTIONS

#### 6.3.1. POSITIONING OF ELECTROSPINDLE

When choosing the location for the electrospindle, ensure a clearance of at least 100mm from the grille of the electric fan, so as not to obstruct the flow of cooling air.

The electric fan protection is IP21; (the electrospindle protection is IP54). Ensure that the electric fan sucks in sufficient air for its IP protective rating, as otherwise it may be damaged.

#### 6.3.2. ELECTROSPINDLE RESTING SURFACE



The resting surface where the electrospindle is fixed must have a planarity of less than 0.02mm.

### 6.3.3. TOOL CHANGE SYSTEM

The tool holder magazine must position the cones with a concentricity error between the spindle shaft axis and the tool holder cone axis of 0.2mm.

### 6.3.4. FIXING ELECTROSPINDLE

The electrospindle should be fixed to the slide or the spindle holder support, using M6 screws with a tightening torque of 8Nm. The depth of the thread is shown in the drawing. Please don't exceed the maximum depth with the screw because it can deform the framework of the electrospindle and produce incorrect blocking and the breaking of the thread, with negative consequences for the precision of the machining operation and the safety.

	<p><b>Maximum protrusion of the screw: 15mm.</b></p> <p><b>Ensure a gap of at least 1mm</b></p> <p><b>Greater protrusions deform the framework of the electrospindle, compromising the precision of the machining operation and also the safety.</b></p> <p><b>Use the tang slot 8H8 to align the electrospindle.</b></p>
	<p><b>While fixing the unit in place, take care not to block off the cooling fan grill or otherwise impede the flow of cooling air. Always leave the maximum gap around the unit specified in the overall dimension drawings (100mm).</b></p>

## 6.4. PNEUMATIC CONNECTION

### 6.4.1. AIR PURITY

	<p><b>Supply the electrospindle with compressed air in accordance with ISO 8573-1, classes 2,4,3:</b></p> <ul style="list-style-type: none"> <li>• <b>class 2 for solid particles: solid particles size &lt; 1µm</b></li> <li>• <b>class 4 for the humidity: dew point &lt; 3°C (37.4°F)</b></li> <li>• <b>class 3 for the total oil: concentration of oil &lt; 1mg/m<sup>3</sup></b></li> </ul> <p><b>Failure to comply with these specifications may result in product malfunction. The guarantee is not valid if pollutants are found during repair operations.</b></p>
---	--

	<p><b>Follow the indication below:</b></p> <ul style="list-style-type: none"> <li>• <b><i>If a lubricated air circuit is present in the machine, it should be insulates from the dry air circuit through a non-return valves.</i></b></li> <li>• <b><i>The filters indicated in this section should be installed as near the electrospindle as possible.</i></b></li> <li>• <b><i>Taking into account the fact that the efficiency of the filters is &lt; 100%, it is essential that the machine be fed with properly treated air; as a general guide, introduce compressed air with a purity rating complying with ISO 8573-1, class 7, 6, 4:</i></b> <ul style="list-style-type: none"> <li>○ <b><i>class 7 for solid particles: solid particles size &lt; 40 μm</i></b></li> <li>○ <b><i>class 6 for the humidity: dew point &lt; 10°C (50°F)</i></b></li> <li>○ <b><i>class 4 for the total oil: oil concentration &lt; 5mg/m<sup>3</sup></i></b></li> </ul> </li> <li>• <b><i>at the end of the working day, empty the pneumatic system to enable the automatic purging of filters.</i></b></li> <li>• <b><i>Carry out regular maintenance operations of the filters according to the manufacturer's indications, and replace them when they are saturated and lose effectiveness (approximately every 6/12 months).</i></b></li> </ul>
---	--

### 6.4.2. PNEUMATIC CONNECTION DIAGRAM

	<p><b><i>The cylinder is double-acting: it must be kept under pressure to maintain the piston in the upper position, far from the rotating parts.</i></b></p>
---	---

Item	Description
A1	Tool holder release air inlet (6 bar)
A2	Nose pressurization air inlet (max 1.5bar)
A3	Tool holder hook-up air inlet (6 bar)
A4	Cone cleaning air inlet (1.5-6 bar)
A5	Air cooling (1.5 bar) optional
06	Air filter and drier group
07	Pressure regulator (6bar)
08	Pressure switch (5.5bar)
09	Piston 5/2 valve 1/8"
10	0.1um air filter
11	Air pressure regulator (1.5bar)
12	Cone cleaning 2/2 valve 1/8"
13	Cone cleaning air flow regulator 1/8"
14	Cone cleaning air
15	Nose pressurization air

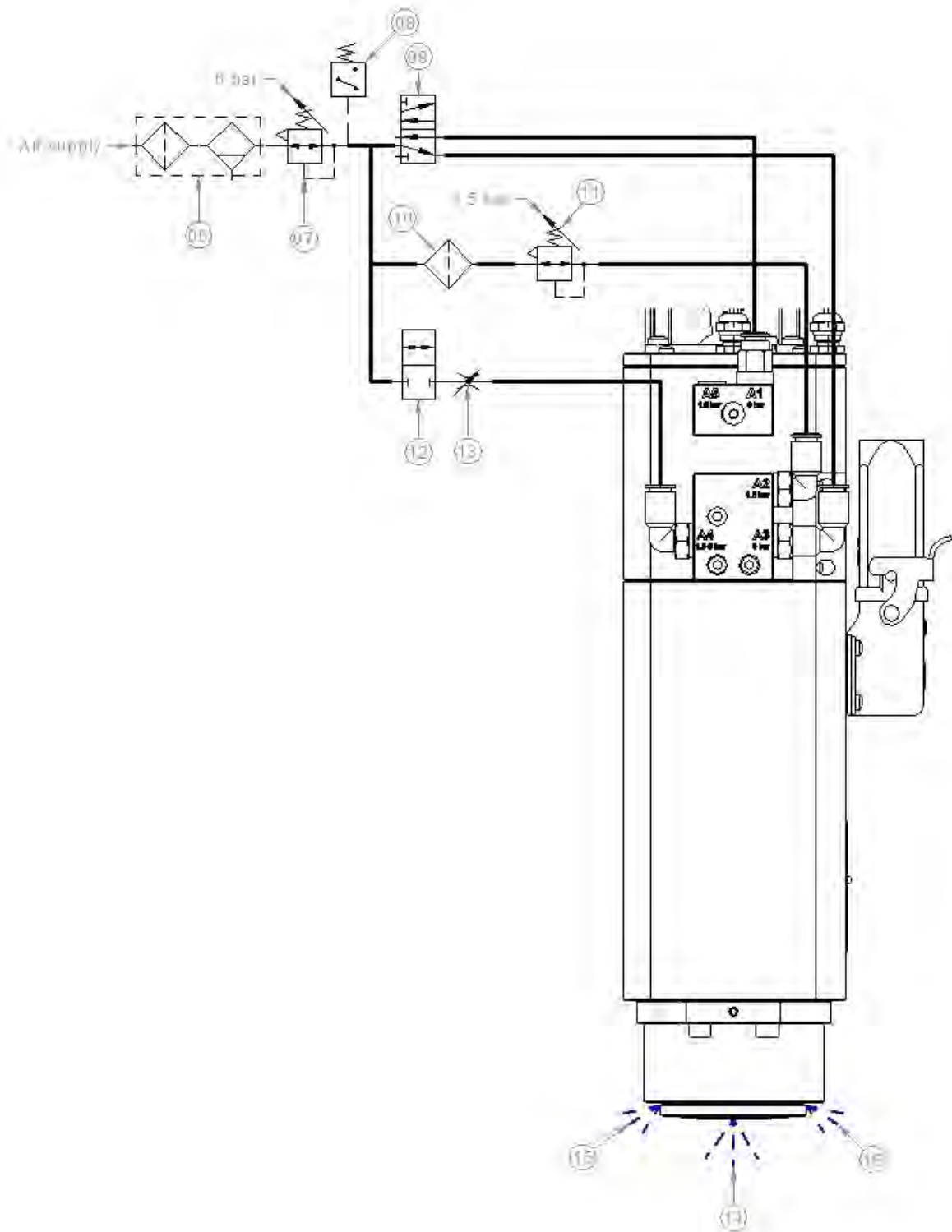

Figure 3 Air connections



### 6.5. PNEUMATIC SPINDLE NOSE CLEANING

The electrospindle is equipped with a pneumatic system that blows through the shaft in order to clean the cone. The customer has to mount a valve as in figure upon. When the toolholder is released the cleaning valve must be open until the tool holder clamping phase.

### 6.6. NOSE PRESSURISATION

The electrospindle nose has pneumatic seals that blocks every dust and coolant particles inside the bearings. The pressurization must be active during all the time even when the electrospindle is not running.

### 6.7. ELECTRICAL CONNECTIONS

See data sheet and inverter configuration.

	<p><b>ATTENTION:</b> <i>always use power cable of adequate cross section for the rated current of the electric motor.</i></p> <p><i>Never fit or remove connectors with the electrospindle powered on.</i></p>
---	--

#### Protections for electric motor

All electrical circuits must be protected against damage resulting from faults or malfunctions due to: short-circuit overloads; overload current; interruption or reduction of the supply voltage; excessive speed of machinery components; overheating in case of a high number of on-load starts. For the safety of the people and/or the objects, protections must be provided against direct contact with live parts and indirect contact with parts which are not live under normal conditions but which may become so in the event of a fault. If the motor shaft stops because of current cut off, it is recommended to take precautions for the stop of the rotation in the opposite direction; if the safety of the machine depends on the direction of the motor shaft, it is recommended to take precautions to avoid an inversion of the phases; in case, the direction of rotation must be indicated with a visible label.

See the inverter manual to determine the kind protections of short-circuit over-current and overload current.

#### 6.7.1. STANDARD LAYOUT OF POWER CONNECTOR

PIN	DESCRIPTION
1	Thermal protection PTC
2	Thermal protection PTC
3	U motor phase
4	V motor phase
5	W motor phase
PE	Ground PE

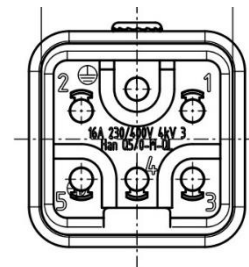

Figure 4 Power supply connector

### 6.7.2. LAYOUT OF SIGNAL CONNECTOR

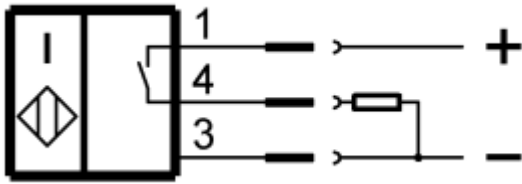

Figure 5 Electrical sensor connection

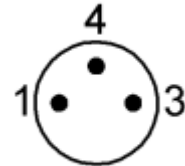

Figure 6 Pin number

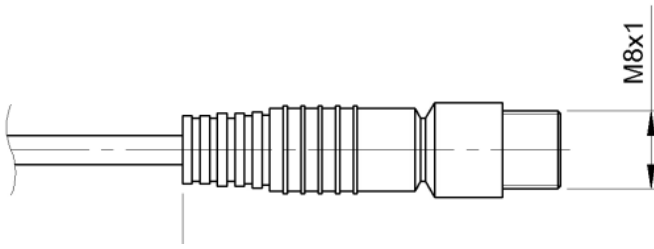



Figure 7 Sensor plug

The sensors are PNP NO (normally open) 24V DC.

### 6.8. ELECTRIC FAN

The electrospindle is cooled by a rear mounted electric fan 24 V DC. The fan must be powered up even when the spindle is not operating. The fan is independent of the spindle shaft. This solution gives improved efficiency compared to shaft mounted fans.

	<p><b><i>The fan must remain ON at all times when the machine is active even if the electrospindle is not operating.</i></b></p>
	<p><b><i>The voltage of the electric fan is printed on the electrospindle name plate.</i></b></p>

# 7. GENERAL CHECKS AFTER INSTALLATION IN THE MACHINE AND PRIOR START-UP

## 7.1. CHECKING ON THE ELECTROSPINDLE PRIOR TO START-UP

### Position

- Make sure that there is sufficient space behind the electrospindle cooling grill, at least 100mm.

### Electrical connection

- Make sure that the electrospindle earthing cable or earthing terminal is connected to the machine earth.
- Make sure that the signal from the motor's thermal protection is suitably processed and connected in series with the machine's stop circuit.

### Programming the inverter

- Make sure that the maximum supply voltage value corresponds to that specified on the electrospindle motor data plate (see section 4.2).
- Make sure that the frequency value at maximum voltage corresponds to that specified on the electrospindle motor data plate (see section 4.2).
- Make sure that the maximum frequency value corresponds to that specified on the electrospindle motor data plate (see section 4.2).
- The inverter must be programmed with the ratio V/f constant.
- Contact Teknomotor S.r.l. if you need to check other inverter parameters.

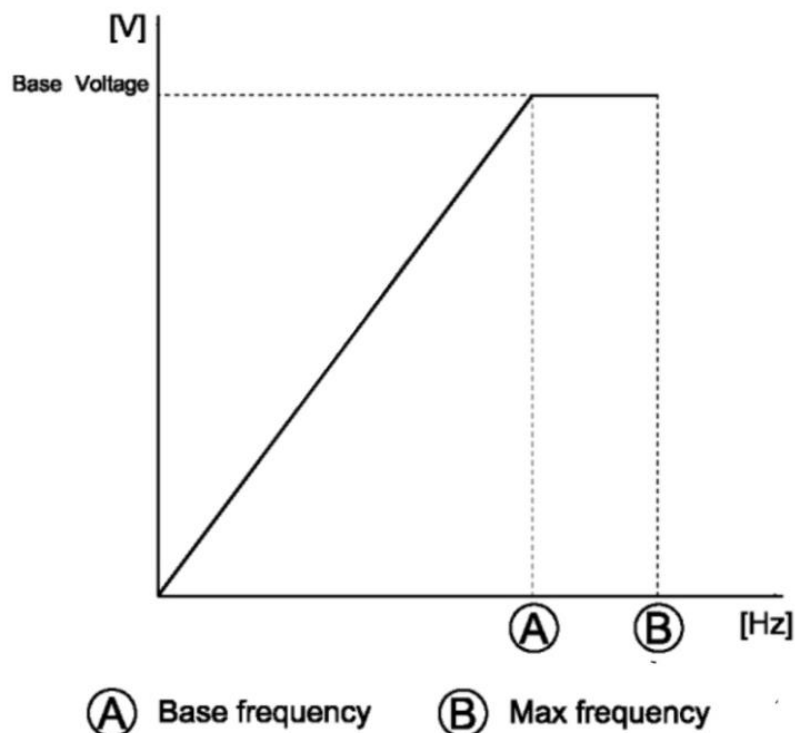





Figure 8 V-f pattern

	<p><b>ATTENTION:</b> <i>wrong inverter setting could cause instantaneous damage on the electrospindle.</i></p>
---	--

## 7.2. CHECKING ON THE ELECROSPINDLE AT THE TIME OF FIRST START-UP

- Check the direction of rotation of spindle shaft corresponds with the NC and with the direction symbol on the body of the electrospindle; the wrong direction of rotation of spindle shaft causes unscrewing of nut.
- Run the electrospindle briefly without load to warm it up (see section 8.4)
- Make sure that the draft of cooling air produced by the fan comes out from all four air channels in the nose of the spindle.

## 7.3. CHECKING ON THE ELECTROSPINDLE BEFORE RUNNING IT

	<p><i>The cylinders of these electrospindles are double-acting: it is necessary to keep the cylinder under pressure to maintain the piston at the upper end stop, far from fast rotating parts.</i></p>
	<p><i>Never run even for small test without air supply. The motor can be damaged, if cylinder move from upper position to a lower position. In the lower position the cylinder make contact with the housing of the ATC to prevent load of cylinder to work on ball bearings. If the motor is running and the cylinder move to lower position it will result in catastrophic failure or the motor.</i></p>

# 8. OPERATION OF THE ELECTROSPINDLE

## 8.1. CLIMATIC LIMITATIONS

Unless specified otherwise, all Teknomotor electrospindles are designed to operate within the following ranges:

- Altitude not above 1000 m above sea level
- Maximum ambient air temperature not above 40°C
- Minimum ambient air temperature not below 10°C

## 8.2. FORECAST AND NON FORECAST USE

Teknomotor electrospindles have been designed to be mounted on a machine tool for the chips removal; it is the customer's responsibility to have any necessary interventions carried out on said machinery in order to render it compliant with Directive 98/37 EC.

The electrospindle can only be used if the machine on which it is going to be mounted has been rendered compliant with Directive 98/37 EC.

Use the electrospindle only to machine materials specified to Teknomotor when placing the order to avoid any inconvenience whatsoever. Generally the electrospindle cannot work in foggy environments or with coolant jet directly in the spindle nose. Specific pneumatic sealed electrospindle are available for such environments (contact our technical office for more information).

Teknomotor S.r.l. declines all responsibility for non-compliance of the electrospindle caused by failure to follow the precautions and instructions given in this manual or by improper use or handling of the electrospindle.

Forecast use:

- Use the electrospindle only for working materials specified at order placement, in general wood, pvc, aluminum.
- Always use sharpened and balanced tools.
- Always use extra precision collets.

Non forecast use:

- Never use the electrospindle in foggy environments or with coolant jet in the spindle nose.
- Never use the electrospindle with too heavy or too long tools
- Before starting the electrospindle always fix it to the machine tool chassis. Never use the electrospindle as a manual tool.
- Never run the electrospindle faster than the maximum speed written on the electrospindle name plate.
- Never run the electrospindle faster than the maximum speed written on the tool body.

In case of any doubt regarding the correct use of electrospindle do not hesitate to contact our technical office.

## 8.3. RUNNING IN

The electrospindle made running in process in the factory, prior to shipment. This ensures correct distribution of the long-life grease in the bearing races. The running in cycle also includes comprehensive testing of all electrospindle electrical mechanical parts.

Before using the electrospindle for the first time it is necessary to operate a short running in to guarantee a correct distribution of the grease inside the bearing.

- Step 1: run the electrospindle at a speed of 3000 rpm for 2 minutes;
- Step 2: increase the speed of 3000 rpm every 2 minutes up to the maximum speed written on the name plate of electrospindle.

Check the temperature of electrospindle nose, if it exceeds the 50°C stop the electrospindle. Restart the running in from the last speed when the electrospindle temperature reaches the ambient temperature.

## 8.4. WARMING UP

Every day, when the electrospindle is started up for the first time, leave it warm up slowly without load. This ensures that the bearings reach their running temperature gradually, and that the bearing races expand evenly. The following warming up cycle is recommended:

50% maximum plated speed for 5 minutes.

Warm the electrospindle up before machining whenever the machine has been left idle long enough for it to cool down to ambient temperature.

## 8.5. TOOL-HOLDER LOCKING AND EXPULSION DEVICE

The blocking and expulsion of the tool-holder is carried out by the movement of a pneumatic piston, it is activated by compressed air.

The tool-holder is mechanically blocked with elastic springs.

Electrospindle model	Axial force on the tool-holder	Expulsion of the tool-holder cone
ISO 20	950N ± 10%	0.5 – 1.5 mm

The electrospindles have a mechanical reaction system that neutralizes the axial force of the piston on the shaft during the tool changing phase, guaranteeing the integrity of the angular contact bearing.

## 8.6. TOOL-HOLDER CONE

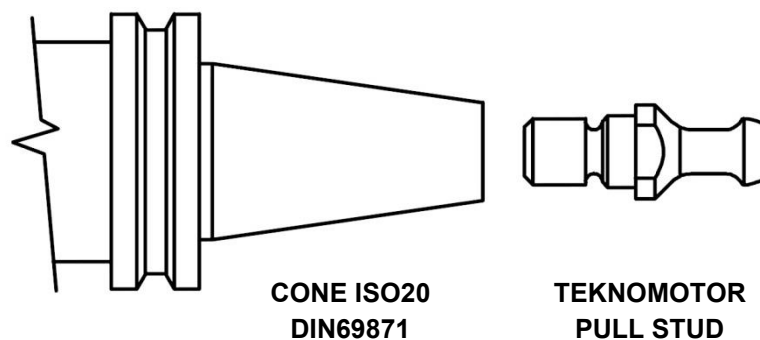



- The taper must respect standard DIN69871 for ISO20;
- The tool-holder ISO30 cone must have AT3 precision rating;
- At maximum rated speed of the electrospindle, the level of dynamic balancing must be G 2.5 or better (ISO 1940 standard);
- The balancing must be carried out with the tool-holder assembled (cone, mill, collet, ring nut, tool);
- The pull stud must be the one supplied by Teknomotor.

## 8.7. INSTALLATION OF THE PULL STUD ON THE ISO20 CONE

- Carefully clean the pull stud and the its housing in the ISO20 cone.

- Cover the thread of pull stud with thread-blocking liquid (LOCTITE 270 or equivalent product).
- Tighten the pull-stud to the cone with a torque of 32 Nm.
- Leave the cone to rest until the thread- blocking liquid becomes solid (see the manufacturer’s instructions).

	<p><b><i>The use of non-original Teknomotor pull stud, or its non-correct installation, may cause the tool-holder accidental release.</i></b></p>
	<p><b><i>It is forbidden to use ISO tool-holders not conforming to the condition described above; failure to observe these instructions represents a source of risk of breakage or incorrect hook-up of the tool-holder cone, with serious risk for the user.</i></b></p>



### 8.8. GENERAL RACCOMANDATION FOR THE TOOL HOLDER CONES

- The choice of tool-holder is determining factor for safety purpose.
- The taper surface of the tool-holder and its housing on the spindle shaft must be kept thoroughly clean in order to permit secure hooking-up.
- During machining operations, be sure to avoid any contact between the non-cutting rotating parts and the piece being machined.
- The seat of the tool-holder cone must always be protected against any impurity that may come in.
- At the end of the working day, always remove the tool-holder cone from the electrospindle, to avoid any problem of it sticking. Replace it with a clean tool-holder cone at room temperature, to protect the inside of the electrospindle against the outer environment.



### 8.9. TOOL MOUNTING – TOOLHOLDER

- 1) Use only fully sharpened tools, and make sure that they are securely locked in the spindle.
- 2) Never use bent or damaged tools, chipped tools, or tools that are not perfectly balanced.
- 3) Do not exceed the speed marked on the tool body or specified in the tool user manual.
- 4) Always ensure that the following essential requisites are met before using any tool at high speed:
  - The tool must be of compact, short, and lightweight design
  - The tool must be a precision instrument, and any inserts must be held into a high degree of security
  - The tool must be balanced and must mate symmetrically with the tool holder
  - The cutting surfaces of the tool must be located near its centre of rotation

	<p><b><i>The recommended balancing degree for tools exceeding the speed of 6000 rpm is G2.5 (ISO 1940 standard) @ maximum speed.</i></b></p>
---	--

	<p><b>FOR TOOL-HOLDER WITH CONICAL SEAT FOR ER DIN 6499</b></p> <p><i>If the tool protrusion is longer than 80mm use absolutely extra precision collets. Please check section 8.10 of this manual.</i></p>
	<p><b>FOR TOOL-HOLDER WITH CILINDRICAL SHAFT</b></p> <p><i>Unless otherwise requested by the customer, tool-holder with tool engagement key are balanced with the key in place (full key balancing – FK).</i></p>

Because of the many factors to consider, it is not possible to summarize in table form the diameters and maximum weights of tools for any specific speed.

	<p><b><i>Always check the maximum operating speed of tools. This is either punched on the tool itself or otherwise specified by the tool manufacturer.</i></b></p> <p><b><i>During machining, take great care to avoid contact between non-cutting rotating parts (spindle shaft, tool-holder, tool ring nut, etc.) and the workpiece or other parts of the machine. Accidental contact can lead to damage to the electrospindle or injury to the operator.</i></b></p> <p><b><i>Never start electrospindle fitted with tool engagement keys without a tool in place and correctly tightened in the tool holder.</i></b></p>
	<p><b><i>The tool edges are very sharp and can provoke serious injuries. always use protection gloves, goggles, clothings, helmets and other personal protection equipment (ppe) during the tool fitting operation.</i></b></p>



## 8.10. TOOL MOUNTING – TOOLHOLDER WITH CONICAL SEAT FOR ER DIN 6499

The tool mounting is a careful operation because it define the electrospindle life.

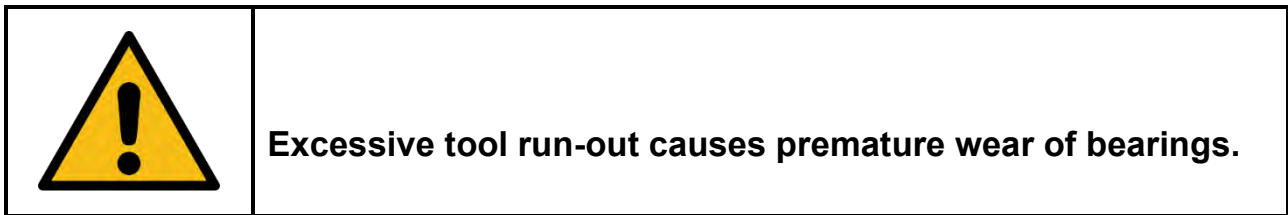

Before fixing the tool on the tool-holder:

- Carefully blow with compressed air the tool holder inside taper, the nut, the collet and the tool.
- Clean them with mix thinner-oil (92%+8%) to remove the processing residual if it is necessary use soft paper.
- Fix the collet on the nut and check that it could turn freely.
- Insert them into the inside taper of the tool-holder and screw the nut by hand.
- Insert the tool and check that it could axially move freely.
- Position the tool in order that the collet clamps the tool on the total length of contact.
- Screw the nut with the advised torque using the specific wrench.
- Check the run out of the tool or if it is not possible check the vibration level of the motor.

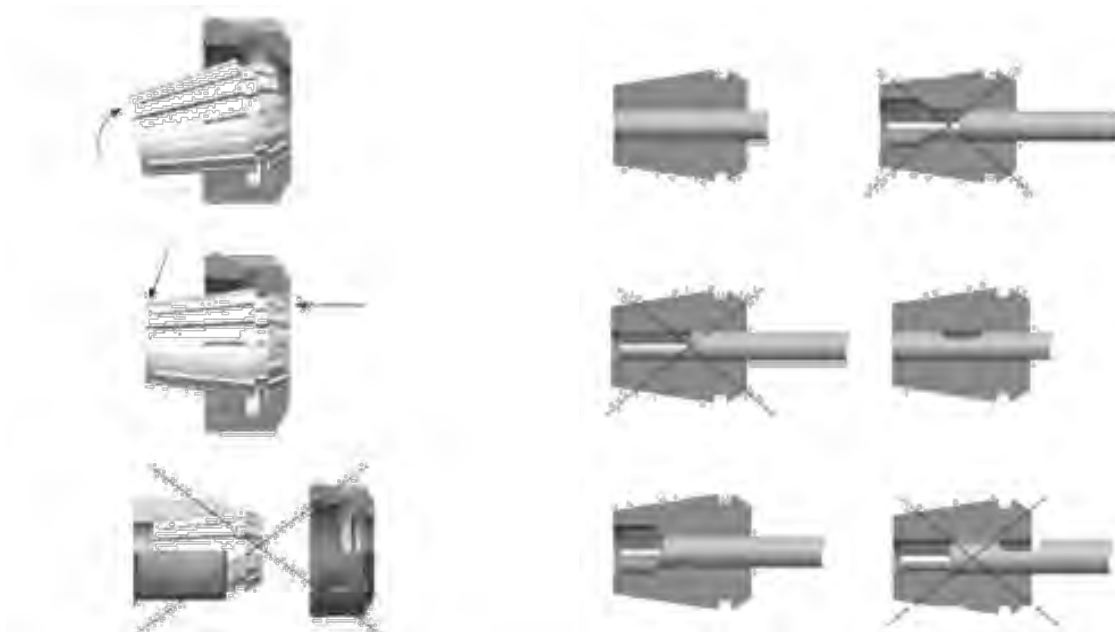

### 8.11. MAXIMUM RUN-OUT AND VIBRATION VALUES

Check that the tool is aligned with the shaft. Use a dial gauge with high resolution (0.001 mm) to measure the tool run-out. The maximum allowed run-out is 0.02mm @ 100mm far from the collet (L1). If it is not possible to measure the tool run-out because of the tool design, use a vibrometer to check the vibration level of the motor. The maximum vibration value should not exceed 2.0-2.5mm/s.

The concentricity values according to DIN 6388 are shown on the following table:

Concentricity collets values				
Ø B mm		L1 mm	DIN6388 mm	Extra precise mm
from	up to			
1.0	1.6	6.0	0.015	0.005
1.6	3.0	10.0	0.015	0.005
3.0	6.0	16.0	0.015	0.005
6.0	10.0	25.0	0.015	0.005
10.0	18.0	40.0	0.020	0.005
18.0	26.0	50.0	0.020	0.005

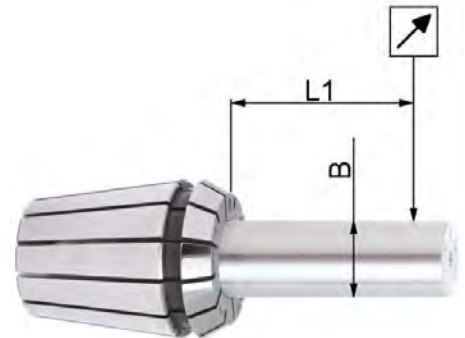

The run-out values of 3 type of collets on the market are shown on the following table:

The experimental results underline that a heavy tool as a milling tool (Ø 16 mm used on the door machine) needs an extra precise collet.

Excessive tool run-out causes a premature wear of the rear bearings as clearly shown on the above table.

	<p><b><u>USE EXTRA PRECISE COLLETS</u> to guarantee a long life of your electrospindle.</b></p>
---	---

### 8.12. SPEED LIMITS

	<p><b>Observe the maximum rotational speed (rpm) specified by the tool manufacturer.</b></p>
---	--

### 8.13. WHAT TO DO IF THE TOOL IS BLOKED ON THE PIECE BEING WORKED

	<p><b><i>If the machine goes into emergency mode or stop with the tool blocked on the piece being worked, do not move the spindle along the Z-axis.</i></b></p>
---	---

Release the piece manually and then carry out the tool changing manually if it is possible.

If it is not possible, proceed in the following way:

- Supply air to the tool changing circuit
- Slowly move the spindle away from the piece, moving it along the Z-axis until the collet opens (“ON” output of sensor S2)
- Check the collet spindle has been freed from the collet
- Move the spindle completely away from the piece being worked
- Remove the blocked tool manually.

### 8.14. SENSORS

The electrospindle is equipped with inductive sensors for monitoring its status, and a thermal alarm to protect the electric coils.

SENSOR	INFORMATION
S1	Tool-holder cone attached correctly
S2	Collet open
S3	Tacho – shaft stopped (OPTION)
S5	Piston at upper position (OPTION)
Thermal alarm PTC	Motor overheated – stop the electrospindle

All the sensors are equipped with output light that turns on when the sensor output turns on. So it is easy to see the functioning of the sensors.

#### 8.14.1. TECHNICAL CHARACTERISTICS OF THE INDUCTIVE SENSORS

Type proximity PNP normally-open (NO)	
Supply voltage	10-30V DC typically 24V DC
Maximum load	100 mA
Power consumption with no load	<10 mA

Nominal detection distance	0.8mm
Max switching frequency	3000Hz
Degree of protection	IP67

### 8.14.2. STATUS MODES OF THE ELECTROSPINDLE AND CORRESPONDING OUTPUTS

	<p><i>The “ON” condition corresponds to an output equal to the supply voltage of the sensor;</i></p> <p><i>The “OFF” condition corresponds to an output equal to 0V.</i></p>
---	--

STATE	S1	S5 (option)	S2	ACTION
Collet open	OFF	OFF	ON	The tool-holder is released.
Collet closed but tool-holder absent	OFF	ON	OFF	The tool-holder is not engaged correctly. It is not allowed machining. The electrospindle cannot run.
Tool-holder blocked correctly	ON	ON	OFF	It is allowed machining.

	<p><i>it is possible to run the electrospindle when the sensors S1 and S5 are both turned “ON”; if the sensor S1 or the sensor S5 turns “OFF” stop immediately the electrospindle shaft rotation.</i></p>
---	---

### 8.14.3. TRIMMING SENSORS

The sensors are already trim in the factory, but if it is necessary to trim the sensors see the following instruction:

- Plug the circular sensor M8 connector and energize it.
- Unscrew 4xM4 screws of the sensors cover as in figure below
- Unscrew the sensor M4 screw a little bit.
- Turn the sensor adjusting nut SW8 until the sensor turns on, continue for 15°, please see the following chapters.
- Tighten the screw M4 while holding the nut SW8.
- Control the correct functioning of the sensor.
- Mount the sensors cover and screw the 4xM4 screws

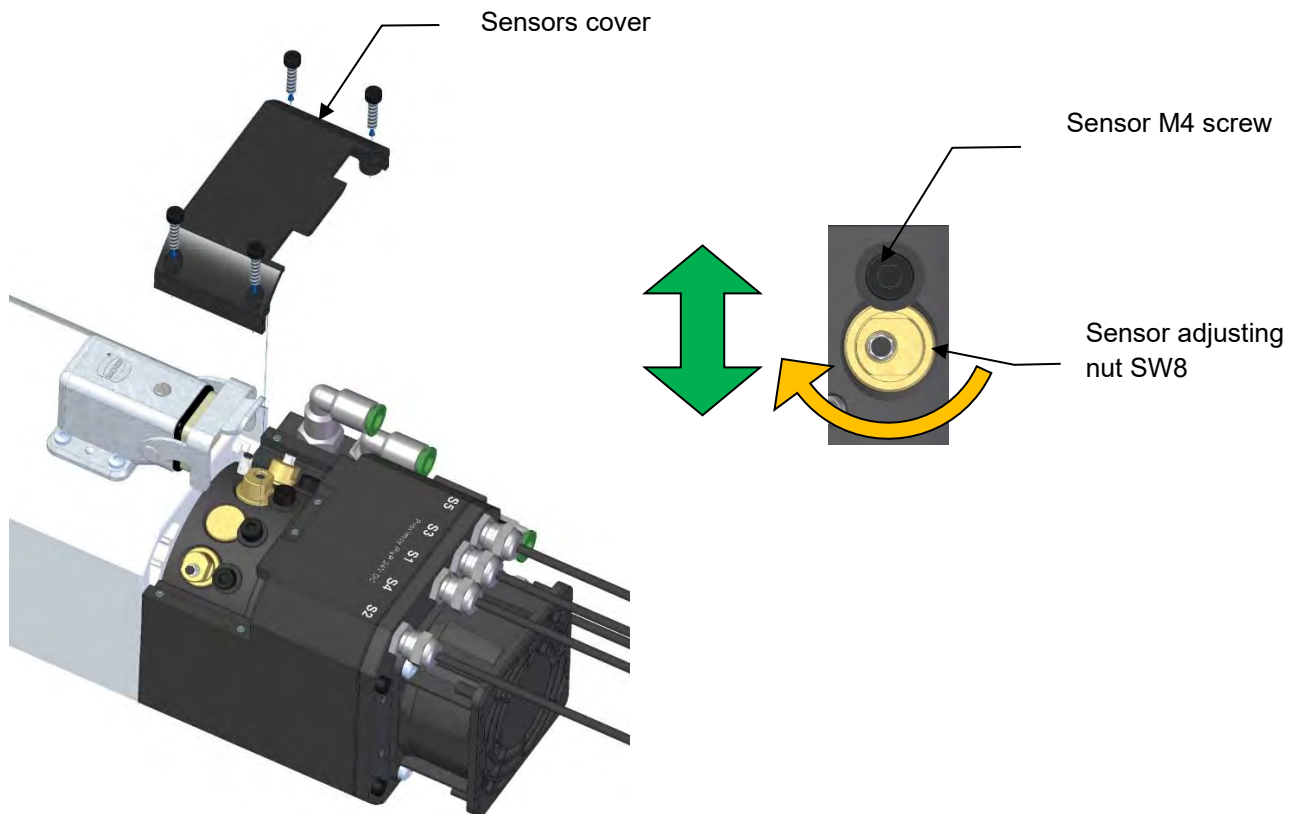

Figure 9 Sensors cover dismounting

Figure 10 Trimming sensor system

#### **S1 SENSOR TRIMMING**

- Engage the toolholder on the electrospindle
- Turn the sensor adjusting nut SW8 until the sensor turns on, continue for 15°
- Change the toolholder and check the sensor runs correctly. Make it for 30 times.
- If sensor doesn't run correctly please repeat the trimming.

#### **S2 SENSOR TRIMMING**

- Act the piston in order to open the collet
- Turn the sensor adjusting nut SW8 until the sensor turns on, continue for 15°
- Change the toolholder and check the sensor runs correctly. Make it for 30 times.
- If sensor doesn't run correctly please repeat the trimming.

### S5 SENSOR TRIMMING (option)

- Act the piston in order to move the piston in the upper position
- Turn the sensor adjusting nut SW8 until the sensor turns on, continue for 15°
- Change the toolholder and check the sensor runs correctly. Make it for 30 times.
- If sensor doesn't run correctly please repeat the trimming.

S3 sensor doesn't need to be trimmed.

### 8.14.4. SENSOR S3 OUTPUT (option)

The output of sensor S3 provides information about the speed of the electrospindle. Sensor S3 works by providing two pulse output per revolution of the shaft. See the diagram below.

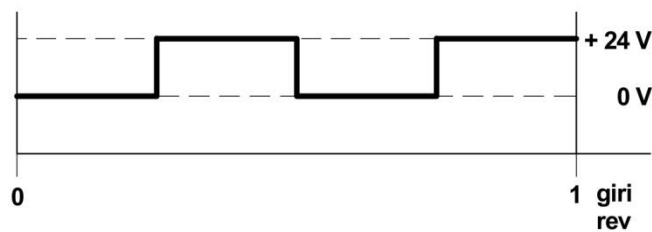

***The sensor frequency switching is higher than the frequency of shaft at maximum speed; so it is possible to control the electrospindle speed range completely.***

***it is possible to use a frequency-analogue converter to convert the S3 sensor digital signal to proportional analogue signal.***

### 8.14.5. THERMAL ALARM

Thermal protection is an important protection in electrospindles. Electrospindles can get heated due to overloading, high ambient temperature, variations in power quality, etc. Thermal overload can result in stator overheating, faulty operation and in some extreme cases even fire. Hence, all motors need to be fitted with protection against thermal overload.

The electrospindle is equipped with a PTC sensor which is mounted in the stator windings. The PTC resistance increases when the stator windings reaches thermal alarm temperature. The resistance will automatically reset once the electrospindle cools to a safe predefined level.

The thermal alarm must be connected to the specific Inverter port.

# 9 MAINTENANCE

Read this section carefully before attempting any maintenance on the electrospindle. This section contains information that is important for the safety of maintenance personnel and for the reliability of maintenance work itself.





All applicable safety precautions must be taken whenever maintenance work is done on the electrospindle. In particular:

- Maintenance and/or lubrication must be performed only by qualified, expert personnel, with the authorization of factory management, in compliance with applicable safety directives and standards, and with the use of suitable tools and instruments.
- When performing maintenance, always wear suitable clothing such as tight fitting work overalls and safety shoes. Never wear long or slack clothing or clothes with parts that hang loose.
- When performing maintenance on a machine, cordon it off and mark it clearly with panels stating "MACHINE UNDERGOING MAINTENANCE".

During all maintenance work make sure that the electrospindle is:

- disconnected and insulated from the electrical power supply;
- fully stopped (not still spinning).

Maintenance managers must ensure that their team is trained to ensure optimum coordination and safety. All persons performing maintenance must remain fully visible to colleagues at all times so that they can signal for assistance if necessary.

	<p><b><i>Use only suitable lifting and moving equipment to disconnect or remove heavy parts from the machine.</i></b></p>
	<p><b><i>Inside the electrospindle there is a pre-loaded spring with a force of several hundred kilograms. The spring is matched to a tie-rod that may fly out violently.</i></b></p> <p><b><i>Carry out the operations described in this manual, paying close attention to the instructions given.</i></b></p>
	<p><b><i>Only the adjustment and replacement operations with original Teknomotor spare parts described in this chapter are permitted.</i></b></p> <p><b><i>Any other type of operation is not permitted and will invalidate the product guarantee.</i></b></p>
	<p><b><i>Special tools are not normally required for electrospindle maintenance.</i></b></p>

## 9.1. SCHEDULED MAINTENANCE AND CLEANING THE SPINDLE SHAFT TOOL HOUSING

Always keep the tool housing in the spindle shaft perfectly clean and free from dust, grease, coolant, oil, metal shavings, and corrosion or lime scale.

Dirty housings cause incorrect tool seating, misalignment with respect to the spindle’s axis of rotation, and tool slippage. Dirt can also damage the surface of the housing, causing poor machining precision, and causing risk of injury to operating personnel.

For this reason, check at every tool change for the manual tool changing spindles and at least once a day for the automatic tool changer electrospindle that the surfaces of the spindle shaft, taper, tool housing and tool itself are perfectly clean.

These parts can be cleaned using standard commercial detergents for metal surfaces. When cleaning, take the opportunity to check the condition of the surfaces for wear or damage.

### 9.1.1. CHECK THE GRIPPER TIGHTENING

**Frequency: DAILY**

Before using the electrospindle, ensure that the gripper is in the correct position and it is tightened correctly. In the open collet position measure the distance between gripper and the shaft (E.M. distance). If the E.M. distance change during the checks means that the gripper is not tightened correctly. Please screw the gripper in the correct position and tighten it.

### 9.1.2. CHECK THE CLEANING OF TOOL-HOLDER CONE AND CONICAL HOUSING OF THE ELECTROSPINDLE SHAFT

**Frequency: DAILY**

Before using the electrospindle, ensure that the conical surface of the tool-holders and the conical surface of the electrospindle shaft are thoroughly clean, with no particles of dust, grease, cooling liquid, oil etc.



ISO

Conical surface of the ISO tool-holder (highlighted in black)

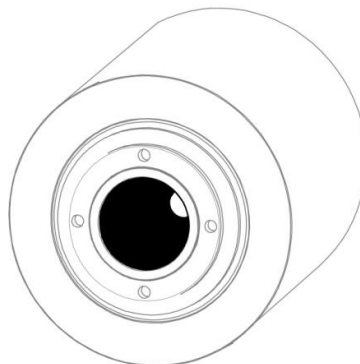

Conical surface of the ISO spindle shaft (highlighted in black)





	<p><b><i>Do no direct jets of compressed air into the spindle shaft when the tool-holder is absent.</i></b></p> <p><b><i>Do no direct jets of compressed air on the nose spindle and in particular in seals labyrinth area.</i></b></p>
---	---



### 9.1.3. PROTECTING THE CONICAL SEAT IN THE SPINDLE SHAFT

Frequency: **DAILY**

	<p><i>The seat of the electrospindle shaft cone must always be protected from impurities: use a closing device.</i></p>
	<p><i>At the end of the day when the machining operations are finished, always remove the tool-holder from the electrospindle to avoid any problem of sticking between tool-holder and electrospindle shaft. Protect the electrospindle shaft cone from dust.</i></p>

### 9.1.4. CLEANING THE TOOL-HOLDER CONE

Frequency: **EVERY TWO WEEKS**

Carefully clean the conical surface of the tool-holders with a clean soft cloth and ethyl alcohol.

### 9.1.5. CHECK THE CONNECTIONS

Frequency: **MONTHLY**

Check the integrity of the electrical cables of both power and signal and the fixing of connector. Check the seal of the tubes and connectors of the compressed air circuits.

## 9.2. OCCASIONAL MAINTENANCE

Clean the grill of the cooling fan and remove any objects blocking the airways and control the fixing screws.

	<p><i>The bearings are lubricated for life and do not require greasing.</i></p>
---	---

Component parts must be removed and refitted only by qualified personnel authorized by Teknomotor S.r.l.

	<p><i>Only replacement of parts with original Teknomotor spares and the subsequent adjustment of the newly fitted parts is authorized. No other type of work is authorized and, if it is done, it will lead to the cancellation of the warranty. Please contact Teknomotor S.r.l. if you need more information.</i></p>
---	---

## 10. TROUBLESHOOTING

PROBLEM	PROBABLE CAUSE	CORRECTIVE ACTION
<b>Excessive vibration during machining</b>	<ul style="list-style-type: none"> <li>• Unbalanced tool.</li> <li>• Incorrectly fitted tool.</li> <li>• Excessive cutting parameters.</li> <li>• Incorrect inverter settings.</li> <li>• Tool too big or too heavy.</li> </ul>	<ul style="list-style-type: none"> <li>• Balance the tool.</li> <li>• Check that the tool is correctly fitted.</li> <li>• Adjust (reduce or increase) the various cutting parameters.</li> <li>• Check the inverter settings.</li> <li>• Try machining with smaller tools.</li> </ul>
<b>Bearings noise</b>	<ul style="list-style-type: none"> <li>• Damaged bearings.</li> </ul>	<ul style="list-style-type: none"> <li>• Send the electrospindle to Teknomotor S.r.l.</li> </ul>
<b>The electrospindle get very hot and is stopped by the PTC thermistor signal</b>	<ul style="list-style-type: none"> <li>• Incorrect inverter settings.</li> <li>• Power settings too high.</li> <li>• Machining speeds too low for the power requirement.</li> <li>• Cooling fan grill blocked.</li> <li>• Cooling fan broken.</li> </ul>	<ul style="list-style-type: none"> <li>• Set the inverter parameters according to the plated values.</li> <li>• Contact the Teknomotor Technical Office.</li> <li>• Check the cooling fan grill and remove any blockage.</li> <li>• Replace the broken fan.</li> </ul>
<b>S1 sensor doesn't run</b>	<ul style="list-style-type: none"> <li>• The sensor is not plugged correctly</li> <li>• The sensor is not energized</li> <li>• The tool holder is not the proper tool holder</li> <li>• The pull stud is not correctly fixed on the tool holder</li> <li>• The sensor is not in the correct position</li> </ul>	<ul style="list-style-type: none"> <li>• Check the sensor connection</li> <li>• Check the sensor power supply</li> <li>• Check the tool holder type</li> <li>• Check the pull stud tightening</li> <li>• Trim the sensor</li> </ul>
<b>S2 sensor doesn't run</b>	<ul style="list-style-type: none"> <li>• The sensor is not plugged correctly</li> <li>• The sensor is not energized</li> <li>• No air pressure</li> <li>• The sensor is not in the correct position</li> </ul>	<ul style="list-style-type: none"> <li>• Check the sensor connection</li> <li>• Check the sensor power supply</li> <li>• Check the pneumatic circuit</li> <li>• Trim the sensor</li> </ul>
<b>S3 sensor doesn't run</b>	<ul style="list-style-type: none"> <li>• The sensor is not plugged correctly</li> <li>• The sensor is not energized</li> </ul>	<ul style="list-style-type: none"> <li>• Check the sensor connection</li> <li>• Check the sensor power supply</li> </ul>
<b>S5 sensor doesn't run</b>	<ul style="list-style-type: none"> <li>• The sensor is not plugged correctly</li> <li>• The sensor is not energized</li> <li>• No air pressure</li> <li>• The sensor is not in the correct position</li> </ul>	<ul style="list-style-type: none"> <li>• Check the sensor connection</li> <li>• Check the sensor power supply</li> <li>• Check the pneumatic circuit</li> <li>• Trim the sensor</li> </ul>

## 11. DISPOSING OF THE ELECTROSPINDLE

At the end of the electrospindle working life it is the customer's responsibility to dispose of it correctly. First of all, clean the unit and separate the various components into mechanical and electrical parts. Then separate the component parts according to type of material: electric motors (copper windings), metal parts (body, etc.), plastic parts, etc.. Dispose of the various materials in compliance with the laws and regulations applicable in the country where the electrospindle has been installed.

## 12. USEFULL ADDRESSES

Headquarters: Teknomotor S.r.l.  
Via Argenega, 31  
32038 Quero Vas (BL)  
Italy

Tel. 0039 0439 787950  
Fax 0039 0439 780147

Website: [www.teknomotor.com](http://www.teknomotor.com)  
Sales: [info@teknomotor.com](mailto:info@teknomotor.com)  
Technical Office: [tecnico@teknomotor.com](mailto:tecnico@teknomotor.com)  
Administration: [amministrazione@teknomotor.com](mailto:amministrazione@teknomotor.com)  
Purchase department: [acquisti@teknomotor.com](mailto:acquisti@teknomotor.com)



# **APPENDIX: ATC41 DRAWINGS AND POWER-TORQUE CURVES**

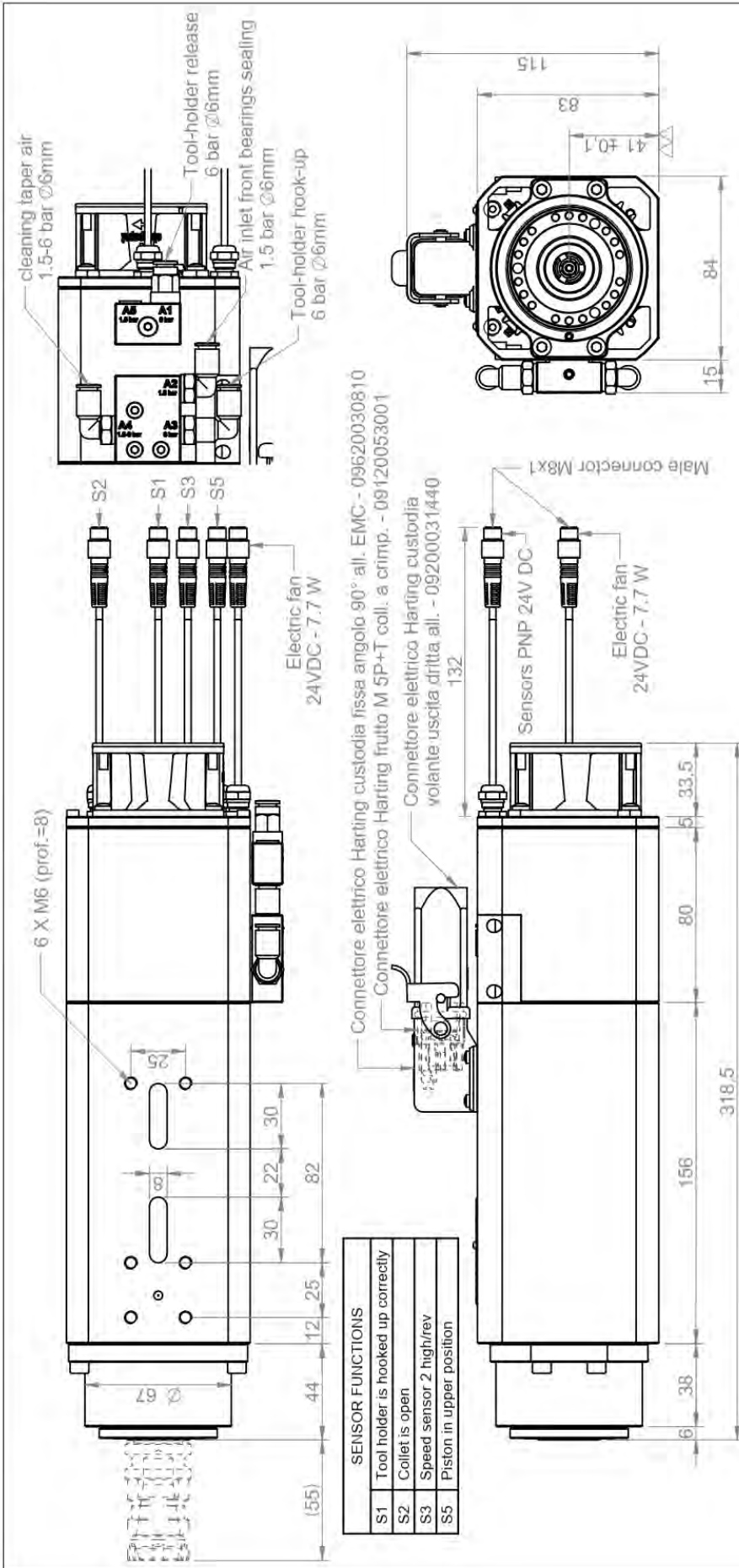

**PLUG CONNECTION**  
 pin #1: PTC  
 pin #2: PTC  
 pin #3: U  
 pin #4: V  
 pin #5: W

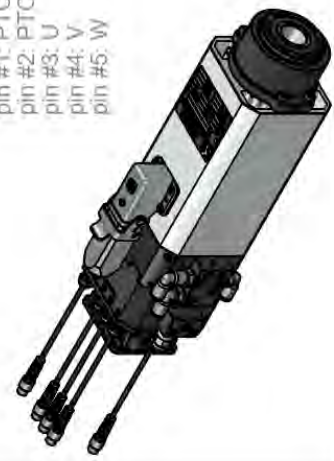

		Teknomotor S.r.l. Via Argentea 31, I-32038 Quero Vas (BL) www.teknomotor.com	
Title ATC41-A-DB-ISO20-SN		Customer Catalogo	
Drawing code COMTC410001		Drawing code COMTC410001	
sheet / sheets 1 / 1		sheet / sheets n.d.	
A4		A4	
Power (kW): 1.1	Duty Cycle: S6-60%	Base speed (rpm): 18000	Base freq. (Hz): 300
Min speed (rpm): 6000	Max speed (rpm): 24000	Absorb. Δ (A): 4.3	Absorb. Y (A): 220
Balancing according to ISO 1940 - G2.5 @ 24000rpm		Balancing type	
Tolleranza non sterzile UNI EN 22768 G1		Smussi non quotati: 0.5mm	
rev. n°	description	IP54	Ins. Cl
00	Emissione	10/05/2017	F
D. Bottarel - 10/05/2017	S. Peiti - 10/05/2017	10/05/2017	COMTC410001
approved - date	checked - date	date	Part number in nomenclature
S. Peiti - 10/05/2017	S. Peiti - 10/05/2017	10/05/2017	COMTC410001
approved - date	checked - date	date	Weight
S. Peiti - 10/05/2017	S. Peiti - 10/05/2017	10/05/2017	5.92 kg
approved - date	checked - date	date	Signature
S. Peiti - 10/05/2017	S. Peiti - 10/05/2017	10/05/2017	D. Bottarel
approved - date	checked - date	date	Signature
S. Peiti - 10/05/2017	S. Peiti - 10/05/2017	10/05/2017	D. Bottarel

Il presente disegno è di proprietà esclusiva di Teknomotor S.r.l. La riproduzione di tale air package e la divulgazione a terzi, senza nostro esplicito consenso scritto, verrà considerata scorretta (rammichi di legge in vigore).

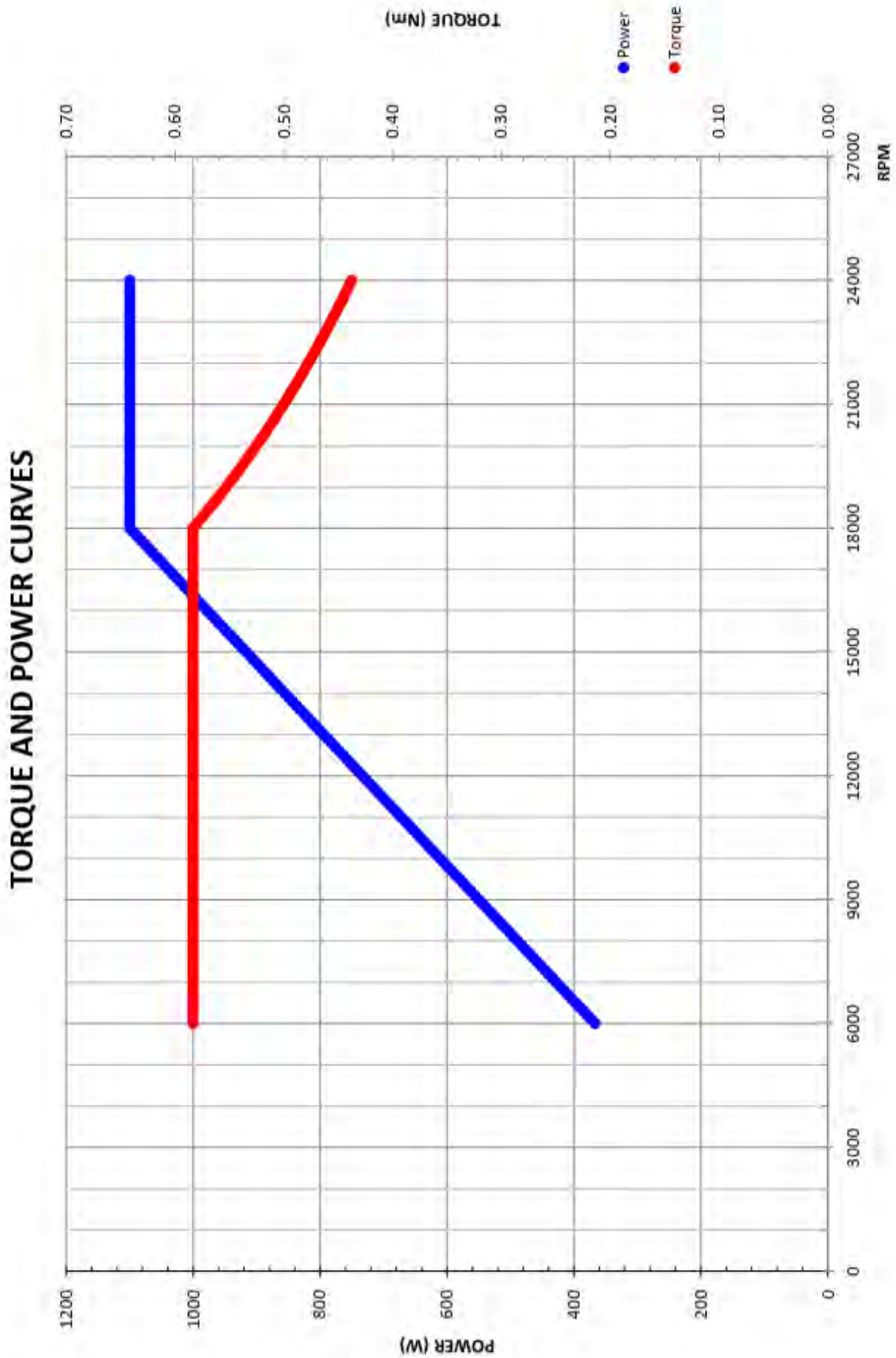

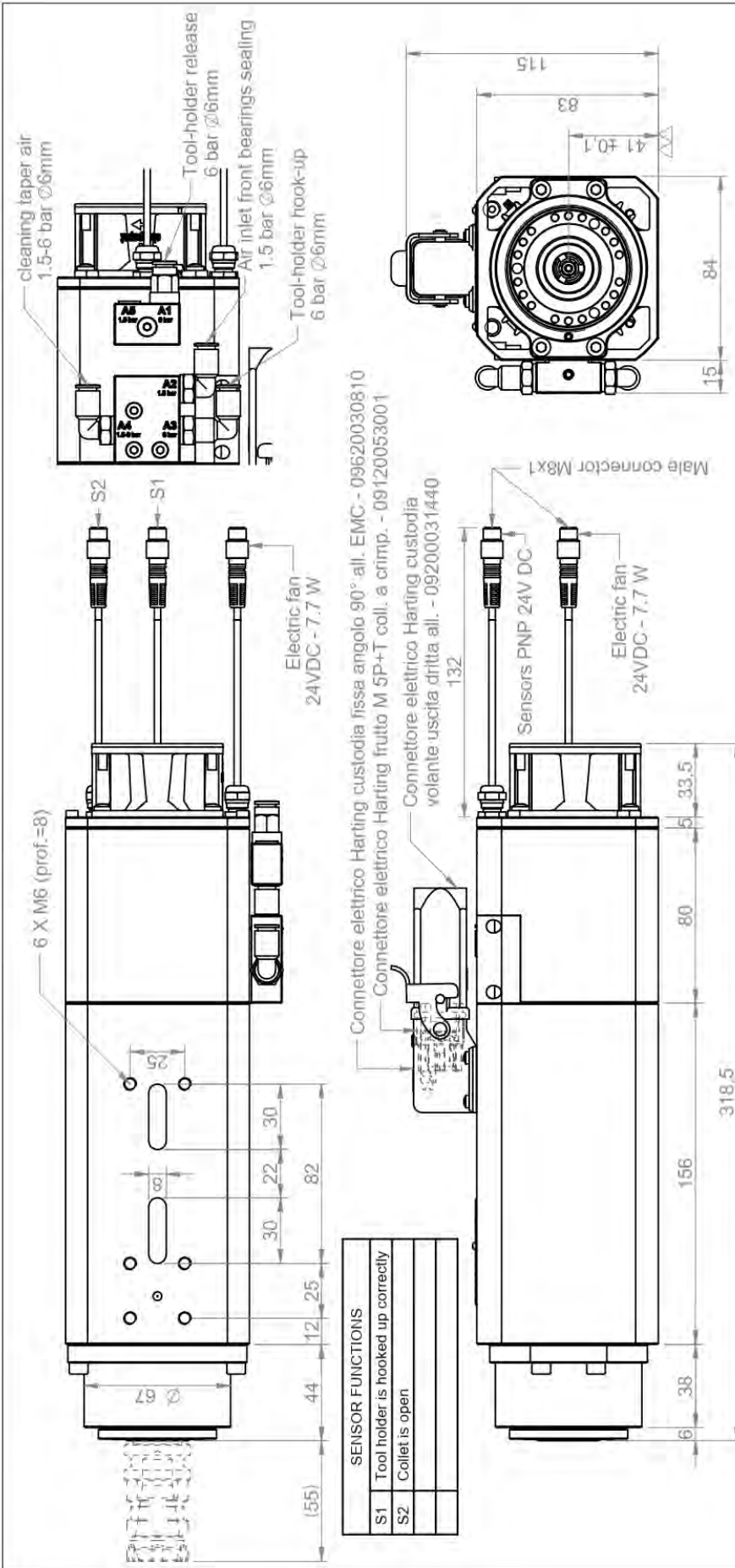

<b>TEKNOMOTOR</b>		Teknomotor S.r.l. Via Argenteo 31, I-32038 Quero Vas (BL) www.teknomotor.com	
Title: <b>ATC41-A-DB-ISO20-SN S1/S2</b>			
Customer: <b>Catalogo</b>		Drawing code: <b>COMTC410002</b>	
Ins. Cl: <b>F</b>		Protection: <b>IP54</b>	
Part number on nameplate: <b>COMTC410002</b>		Weight: <b>5,92 Kg</b>	
Base voltage V [V]: <b>220</b>		Base voltage V [V]: <b>220</b>	
Absorb. Δ [A]: <b>4.3</b>		Absorb. V [A]: <b>4.3</b>	
Base freq. [Hz]: <b>300</b>		Base freq. [Hz]: <b>300</b>	
Max speed [rpm]: <b>24000</b>		Max speed [rpm]: <b>24000</b>	
Min speed [rpm]: <b>6000</b>		Min speed [rpm]: <b>6000</b>	
Duty Cycle: <b>S6 60%</b>		Duty Cycle: <b>S6 60%</b>	
Balancing according to ISO 1940-132.5 @ 24000 rpm		Balancing type: <b>0.5</b>	
Tolleranze non quote: UNI EN 12768 (F)		Tolleranze non quote: <b>0.5mm</b>	
rev. n°: <b>00</b>		description: <b>Emissione</b>	
approved - date: <b>D. Bottarel - 16/04/2019</b>		checked - date: <b>S. Perli - 16/04/2019</b>	
approved - date: <b>S. Perli - 16/04/2019</b>		checked - date: <b>S. Perli - 16/04/2019</b>	
drawing - date: <b>D. Bottarel - 16/04/2019</b>		checked - date: <b>S. Perli - 16/04/2019</b>	
signature: <b>D. Bottarel</b>		signature: <b>D. Bottarel</b>	
date: <b>16/04/2019</b>		date: <b>16/04/2019</b>	
scale: <b>n.d.</b>		scale: <b>n.d.</b>	
sheet: <b>1/1</b>		sheet: <b>1/1</b>	
drawing code: <b>COMTC410002</b>		drawing code: <b>COMTC410002</b>	
A4		A4	

PLUG CONNECTION  
 pin #1: PTC  
 pin #2: PTC  
 pin #3: U  
 pin #4: V  
 pin #5: W

